



Mf sport

**sports equipment
2017/2018**



Endlich da – MFsport Katalog 2017/2018!

Wir freuen uns Ihnen den neuen MFsport Katalog präsentieren zu können. Auf den folgenden Seiten stellen wir Ihnen unsere zahlreichen Produktneheiten sowie bewährte Fitness- und Trainingsgeräte vor. Gerne berät Sie unser sachkundiges Team bei Fragen aller Art!

Viel Spaß beim Blättern wünscht Ihnen, MFsport – Ihr Partner für den gemeinsamen Trainingserfolg!

MFsport Catalogue 2017/2018

We are pleased to present our new MFsport Catalogue. On the following pages we present our new products as well as established fitness and exercise machines. Our experts would be pleased to answer your questions!

Enjoy the catalogue! MFsport – your partner for common success in training!



Inhalt

Olympic Zubehör ø 50 mm Olympic accessories ø 50 mm	4
Olympic Guss- und Gummischeiben ø 50 mm	5
Olympic cast iron and rubber discs ø 50 mm	
Olympic Hantelstangen ø 50 mm Olympic bars ø 50 mm	6
Olympic Hantelstangen und Zubehör ø 50 mm	7
Olympic bars ø 50 mm and accessories	
Hantelstangen und Zubehör ø 30 mm bars and accessories ø 30 mm	8
Guss- und Gummischeiben ø 30 mm, Scheibenständer	9
cast iron and rubber plates ø 30 mm, disc racks	
Get fit ø 30 mm Get Fit ø 30 mm	10
Gebrauchsmustergeschützte DSN-Hanteln	11 -12
patented DSN-dumbbells	
Hantelständer Kombisystem für Guss- und Gummihanteln	13
dumbbell rack for cast iron and rubber dumbbells	
Monoblock Hanteln und Ablage monobloc dumbbells and rack	14
Monoblock Langhanteln und Ablage monobloc barbells and rack	15
Polyurethan (PU) Kurz- und Langhanteln, Ø50mm Hantelscheiben	16
PU dumbbells, barbells and Ø50mm discs	
Ablagen für Langhanteln racks for barbells	17
Kettlebells kettlebells	18
Chromhanteln und Ständer chrome dumbbells and rack	19
PVC-Hanteln und Ablagen pvc-dumbbells and racks	20
Latzugstangen lat bars	21
Trizepsgriffe triceps grips	22
Bügelzug- und Hufgriffe single hand grips and horse shoe grips	23
Parallel- und Multigriffe seated lat bars and multiple grips	24
Seile und Ständer ropes and racks	25
Sportgeräte Auswahl sports machines selection	26 - 27
Cross fit Cross fit	28
Gymnastik- und Medizinbälle inkl. Ablagen	29
gymnastic and medicine balls incl. racks	
Halbball, Bauchabroller, Igelbälle, Ringe	30
half ball, abdominal trainer, hedge-hog balls, rings	
Toner, Bodybänder und Tubes toner, body-bands and tubes	31
Jump-Stretch, Cuff-Tubes, Fitnessbänder	32
jump-stretch, cuff-tubes, fitness-bands	
Gymnastikmatten und Mattenhalter gymnastic mats and mat racks	33
Pilates- und Gymnastikartikel pilates and gymnastic accessories	34
Workout Bars, Ablage und Steps workout bars, rack and steps	35
Univeralbank, Geräteunterlagen universal bench, floor protect mats	36
Handschuhe, Gewichtsmanschetten, Gravity Boots	37
gloves, wrist and ankle weights, gravity boots	
Trainingszubehör training accessories	38-39

Olympic Zubehör ø 50 mm | Olympic accessories ø 50 mm

Art.-Nr.
60-8 2 x 8 kg
60-12 2 x 12 kg
60-16 2 x 16 kg
Ketten inkl. Feststeller
ca. 150 cm lang
chains incl. fasteners
150 cm

Art.-Nr. K7714
Drückerbank ohne Zubehör
Standard: Gestell silbergrau,
Bezugsstoff schwarz
RAL-Lackierungen und Stoffe
aller Art sind möglich!
power bench without
accessories
standard: rack silvergrey,
upholstery black
Other RAL-colors and uphol-
stery are possible!



Art.-Nr. K7719-G1
Scheibenständer für Scheiben bis 25 kg
(ohne Scheiben) RAL 9006
disc rack for discs up to 25 kg
(without discs)



Art.-Nr. K7719-1
Scheibenständer für Scheiben bis 10 kg
(ohne Scheiben) RAL 9006
disc rack small for discs up to 10 kg
(without discs)



Art.-Nr. K7719-RG
Scheibenständer für 50 mm Scheiben
Maße: 60 cm x 80 cm x 125 cm
(silbergrau)
disc rack for 50 mm discs
size: 60 cm x 80 cm x 125 cm
(silvergrey)

Olympic Guss-, Gummischeiben ø 50 mm | Olympic cast iron and rubber discs ø 50 mm

Gummischeiben farbig mit Griffen und Edelstahlbuchse, **colour rubber discs with grips and stainless steel bushing**

Art.-Nr.		
50GB0125	1,25 kg	gelb yellow
50GB0250	2,50 kg	blau blue
50GB0500	5,00 kg	rot red
50GB1000	10,00 kg	grün green
50GB1500	15,00 kg	gelb yellow
50GB2000	20,00 kg	blau blue
50GB2500	25,00 kg	rot red



Gummischeiben schwarz, mit Edelstahlbuchse **rubber discs, black, with stainless steel bushing**

Art.-Nr.	
50G0125	1,25 kg
50G0250	2,50 kg
50G0500	5,00 kg
50G1000	10,00 kg
50G1500	15,00 kg
50G2000	20,00 kg
50G2500	25,00 kg



Gummischeiben mit Griff (schwarz) **rubber discs (with grips/black)**

Art.-Nr.	
50GE0125	1,25 kg
50GE0250	2,50 kg
50GE0500	5,00 kg
50GE1000	10,00 kg
50GE1500	15,00 kg
50GE2000	20,00 kg
50GE2500	25,00 kg



Gussscheiben mit Griff (grau) **cast iron discs with grips (grey)**

Art.-Nr.	
62720-RG	1,25 kg
62721-RG	2,50 kg
62722-RG	5,00 kg
62723-RG	10,00 kg
62724-RG	15,00 kg
62725-RG	20,00 kg
62726-RG	25,00 kg



Olympic Hantelstangen ø 50 mm | Olympic bars ø 50 mm



Art.-Nr. 62250

Wettbewerbstange, Federstahl, Gewicht 20 kg, Länge 220 cm, Ni-P., max. Belastbarkeit 700kg
Geeignet für Wettbewerbe (schwere Kniebeugen möglich).

competition bar, spring steel, weight 20 kg, length 220 cm, Ni-P.

Art. 62250-B

Wettbewerbsstange auch in schwarz erhältlich

competition bar, also available in black



Art.-Nr. 62234

Hantelstange 220 cm, Gewicht 20 kg, Ni-P, mit Kugellager, max. Belastbarkeit 300kg,
geeignet für kleinere Wettkämpfe (mittelschwere Kniebeugen möglich).

bar, length 220 cm, weight 20 kg, Ni-P.



Art.-Nr. 62235

Hantelstange 220 cm, Gewicht 20 kg, Ni-P, max. Belastbarkeit 200kg,
geeignet für Bankdrücken (für Kniebeugen nicht geeignet).

bar, weight 20 kg, length 220 cm, Ni-P, suitable for bench presses up to 200 kg.



Art.-Nr. 62212

Economy-Hantelstange, 220 cm,

Gewicht 20 kg, Chrom, geeignet für Bankdrücken bis 120 kg (für Kniebeugen nicht geeignet).

economy bar, length 220 cm, weight 20 kg, chrome, suitable for bench presses up to 120 kg.



Art.-Nr. 62714

Lady-Hantelstange 185 cm,

Gewicht 16 kg, Bankdrücken bis 150 kg, Chrom (mittelschwere Kniebeugen möglich).

lady bar, length 185 cm, weight 16 kg, chrome, suitable for bench presse up to 150 kg.



Art.-Nr. 62236

Jugend-Hantelstange 160 cm, Ni-P,

Gewicht 15 kg, mittelschwere Kniebeugen möglich.

junior bar, length 160 cm, Ni-P, weight 15 kg, suitable for bench presses up to 150 kg.



Art.-Nr. 4073

Nackenschutz, 46 cm

neck protector, 46 cm

NEU



Art.-Nr. 62255

Ablage für 9 Olympicstangen

rack for 9 Olympic bars

Olympic Hantelstangen ø 50 mm und Zubehör | Olympic bars ø 50 mm and accessories



Art.-Nr. 62213
SZ-Stange, schwarz, ca. 120 cm, inkl. Stellringe | curl bar, black, approx. 120 cm, incl. ring collars



Art.-Nr. 62214
SZ-Stange, Chrom, ca. 120 cm, inkl. Stellringe | curl bar, chrome, approx. 120 cm, incl. ring collars



Art.-Nr. 62215
Super-SZ-Stange, Chrom, ca. 125 cm, inkl. Stellringe | super curl bar, chrome, approx. 125 cm, incl. ring collars

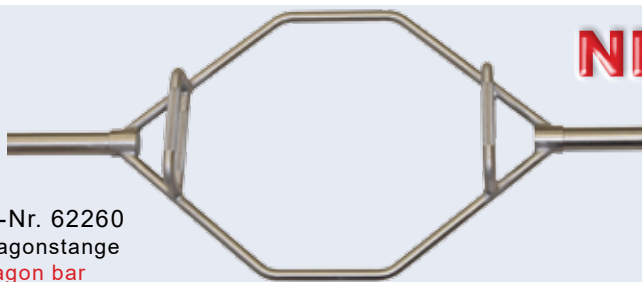

NEU

Art.-Nr. 62260
Hexagonstange
hexagon bar



Art.-Nr. 62071+F
Bizeps-,Trizepsstange inkl. Stellringe
biceps-/tricepsbar incl. ring collars

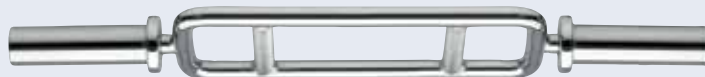

Art.-Nr. 62079+F
Trizepstrainer mit Kugellager inkl. Stellringe
tricepstrainer with ball-bearing incl. ring collars



Art.-Nr. 62711
Sternfeststeller ø 50mm
star fastener



Art.-Nr. 62712
Stellringe ø 50mm
ring collar



Art.-Nr. 62070
Federfeststeller ø 50mm
spring fastener



Art.-Nr. 62070-1
Federfeststeller abgewinkelt ø 50mm
spring fastener angled



Art.-Nr. 62070-2
Feststeller, Kunststoff ø 50mm
olympic fastener, plastic

NEU



Art.-Nr. 62070-3
Federfeststeller gerade ø 50mm
spring fastener straight

Hantelstangen und Zubehör ø 30 mm | bars and accessories ø 30 mm



Art.-Nr. 62200
Kurzhandelstange, inkl. Stellringe
dumbbell bar, short, incl. ring collars



Art.-Nr. 62219
Kurzhandelstange, verchromt, inkl. Sternverschlüsse
dumbbell bar, short, chromium-plated, incl. star fasteners



Art.-Nr. 4041
Trizeps-Trainer, voll, 11kg, inkl. Federfeststeller
tricepstrainer, solid, 11kg, incl. spring fasteners



Art.-Nr. 4073
Nackenschutz, 46 cm
neck protector, 46 cm



Art.-Nr. 23202
SZ-Stange, ca. 120 cm, verchromt, inkl. Stellringe
curled bar, length 120 cm, chromium-plated, incl. ring collars



Art.-Nr. 23201
Langhandelstange, 165 cm, verchromt, inkl. Stellringe
chrome bar, length 165 cm, incl. ring collars



Art.-Nr. 23211
Langhandelstange, 180 cm, verchromt, inkl. Stellringe
chrome bar, length 180 cm, incl. ring collars



Art.-Nr. 23312
Langhandelstange, 200 cm, verchromt, inkl. Stellringe
chrome bar, length 200 cm, incl. ring collars

Alle geraden Stangen auch mit Gewinde und Sternverschluss erhältlich (23201-SV, 23211-SV, 23212-SV)
All straight bars also available with thread and star fastener (23201-SV, 23211-SV, 23212-SV)



Art.-Nr. 62205
Stellring, ø 30 mm
ring collar



Art.-Nr. 622051
Federfeststeller ø 30 mm
spring fastener ø 30 mm



Art.-Nr. 622051-1
Feststeller ø 30 mm, Kunststoff
fastener ø 30 mm, plastic

NEU

**Guß- und Gummischeiben ø 30 mm, Scheibenständer |
cast iron and rubber plates ø 30 mm, disc racks**

Gummischeiben für
30 mm Stangen (mit Innen-
ring, Gewicht +/-5%)

rubber discs for
30 mm bars

Art.-Nr.

3430	0,50 kg
3431	1,25 kg
3432	2,50 kg
3434	5,00 kg
3435	10,00 kg
3436	15,00 kg
3437	20,00 kg



Bunte Gummischeiben mit Edel-
stahlbuchse und Griff
für 30 mm Stangen

colored rubber discs with stainless
steel bushing for 30 mm bars

Art.-Nr.

3430-RG	0,50 kg / grün / green
3431-RG	1,25 kg / gelb / yellow
3432-RG	2,50 kg / blau / blue
3434-RG	5,00 kg / rot / red
3435-RG	10,00 kg / grün / green
3436-RG	15,00 kg / gelb / yellow
3437-RG	20,00 kg / blau / blue



Gusscheiben mit Griff (grau)

cast iron discs with grips (grey)

Art.-Nr.

16310-RG	0,50 kg
16311-RG	1,25 kg
16312-RG	2,50 kg
16313-RG	5,00 kg
16314-RG	10,00 kg
16315-RG	15,00 kg
16316-RG	20,00 kg



Art.-Nr. K7718-RG

Scheibenständer für 30er Scheiben

Maße: 60 cm x 80 cm x 125 cm
(silbergrau)

disc rack for 30 mm discs
size: 60 cm x 80 cm x 125 cm
(silvergrey)



Art.-Nr. K7718-1

Scheibenständer für 30er Scheiben

Maße: 60 cm x 60 cm x 50 cm, RAL 9006
disc rack for 30 mm discs
size: 60 cm x 60 cm x 50 cm, RAL 9006

Get Fit ø 30 mm



Art.-Nr. K23314-F

Get Fit Set farbig, bestehend aus:
Hantelstange, 2 Federfeststeller, je 2
Gummischeiben mit Griff (1,25 kg gelb,
2,50 kg blau 5,00 kg rot), maximale
Belastung 20kg pro Seite

Get Fit Set colored with bar, 2 fasteners
and 2 rubber plates with grips of 1,25
kg yellow, 2,50 kg blue and 5,00 kg red
maximum load 20kg per side



Art.-Nr. K23314-S

Get Fit Set schwarz, bestehend aus:
Hantelstange, 2 Federfeststeller, je 2
Gummischeiben (1 kg - 2 kg - 5 kg)
maximale Belastung 20kg pro Seite

Get Fit Set black with bar, 2 fasteners
and 2 rubber plates of 1kg - 2kg - 5 kg
maximum load 20kg per side



Art.-Nr. K23315

Roll-Wagen
Fahrbarer Hantelstangen- und
Scheibenständer für bis zu 30 Sets,
L/B/H: 157 cm / 65 cm / 156 cm.
mobile rack for max 30 sets of bars,
collars and discs, l/w/h: 157 cm /
65 cm / 156 cm.

Art.-Nr. K23315-1

Ständer-Wagen
Hantelstangen- und Scheibenständer
für bis zu 30 Sets
rack for max. 30 sets of bars,
collars and discs

Standardfarbe: schwarz
Auch in anderen RAL-
Farben lieferbar!

standard colour: black
Also available in
different RAL-colors!

Exklusiv nur bei MFsport!

Seit 30 Jahren montieren wir für Sie vor Ort DSN-Hanteln ab 2kg ganz nach Ihren Wünschen. Die Hanteln sind gewichtsoptimiert, da jede Hantelscheibe einzeln gewogen wird, um übliche Schwankungen festzustellen und auszugleichen. So haben Sie die bestmögliche Gewichtskontrolle. Sonderanfertigungen oder Zwischengrößen sind für uns kein Problem.

Ob Guss- oder Gummihantel, beides ist lieferbar mit und ohne Chromabdeckung.

Ihr Vorteil: Ist eine einzelne Hantel mal defekt, können Sie **alle** Teile der Hantel einzeln nachbestellen bzw. austauschen.

Available exclusively only at MFsport!

For 30 years we have been assembling dumbbells from 2kg according to your wishes. The dumbbells are weight optimized as each dumbbell disc is individually weighed to detect and compensate for normal fluctuations. So you have the best possible weight control. Customized or intermediate sizes are standard for us. Whether cast or rubber, both are available with and without chrome endplates. Your advantage: If a single dumbbell is malfunctioned, you can individually re-order and replace all parts of the dumbbell.



Für unsere Hanteln haben wir natürlich passende Ablagen in unserem Programm. Sollten Sie bereits Ablagen besitzen, prüfen Sie ob unsere Hanteln mit dem Innenmaß von ca. 14,5cm auf Ihre Ablagen passen!

For our dumbbells, we have suitable racks available. If you already have racks, check the distance between the support surfaces before ordering.



Unsere Standard-Hantelsätze:

- 1,0 kg Steigung von 2,00 kg – 26 kg
- 2,0 kg Steigung von 2,00 kg – 60 kg
- 2,5 kg Steigung von 2,50 kg – 60 kg

Alle Hanteln werden mit Gewichtsaufklebern versehen.
All dumbbells with weight stickers.

Höhere Gewichte auf Anfrage!
Higher weights on request!

Gebrauchsmustergeschützte DSN-Hanteln | patented DSN-dumbbells

Art.-Nr. 020EI bis 600EI
Gusshanteln

(cast iron dumbbells)

Art.-Nr. 020EI+P bis 600EI+P
Gusshanteln mit Chromendscheibe

(cast iron dumbbells with chrome endplates)



Art.-Nr. 020G bis 600G

Gummi-hanteln mit Gummiendscheibe
rubber dumbbells with rubber endplates



Art.-Nr. 020G+P bis 600G+P

Gummi-hanteln mit Chromendscheibe
rubber dumbbells with chrome endplates

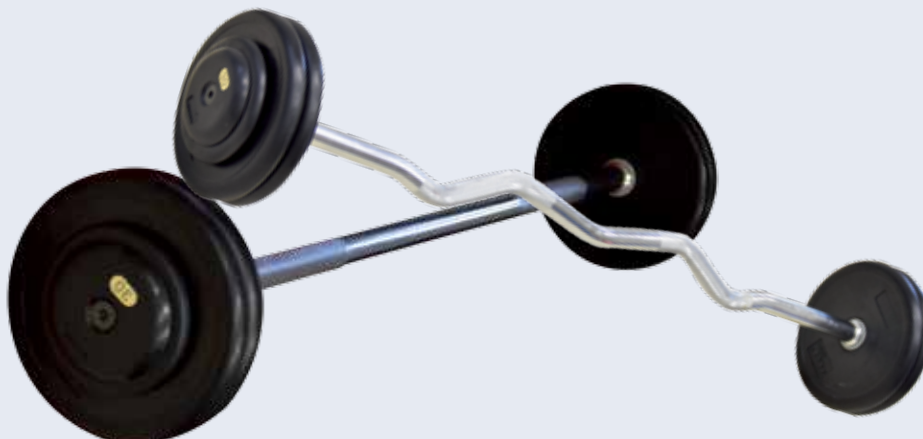

Art.-Nr. 100LG bis 700LG

Gummilanghanteln mit Gummiendscheibe
oder Chromendscheibe

Art.-Nr. 100LG+P bis 700LG+P
rubber barbells with rubber endplates
or chrome endplates

Art.-Nr. 100SZG bis 700SZG

SZ-Gummilanghanteln mit Gummiend-
scheibe oder Chromendscheibe

Art.-Nr. 100SZG+P bis 700SZG+P
curled rubber barbells with rubber endplates
or chrome endplates

Alle Langhanteln auch mit Guss-scheiben erhältlich
All barbells also available with cast iron discs

**Hantelständer Kombisystem für Guss- und Gummihanteln |
dumbbell rack for cast iron and rubber dumbbells**

Sie können zwischen unserem Baukastensystem (erweiterbar und in allen RAL-Tönen erhältlich) und einer dreilagigen Ablage (siehe Seite 14) wählen.

You can choose between our modular system (expandable and available in all RAL tones) and a three-layer rack (see page 14).



**Hantelständer Kombisystem
dumbbell rack combination system**

- Art.-Nr. 7101-11 Hantelablage 1m Schiene/ dumbbell rack 1 m
- Art.-Nr. 7101-151 Hantelablage 1,5m Schiene/ dumbbell rack 1,5 m
- Art.-Nr. 7101-E1 Hantelablage 2m Schiene/ dumbbell rack 2 m
- Art.-Nr. 7101-F1 Hantelablage 3m Schiene/ dumbbell rack 3 m
- Art.-Nr. 7103 Fuß zur Aufnahme von 2 Ablagen/ base for 2 dumbbell racks
- Art.-Nr. 7103 Fuß zur Einzelablage/ base for 1 dumbbell rack

Standardfarbe: RAL 9006

In allen RAL-Tönen mit Aufpreis erhältlich

Available in all RAL-colors with extra charge



- Art.-Nr. 4400 Handschutzpolster aus Vinyl
SANITIZED® - veredelt (antibakteriell und
pilzverhindernd), zertifiziert nach Öko-
Tex-100.
Andere Farben im Wechsel möglich.
hand pads vinyl
The pads are hygienic by SANITIZED®,
certificate Öko-Tex-100.
Neither bacteria nor fungi can exist here.
Color not selectable.



- Art.-Nr. 24 Sattelauflagen für Hantelablage
rubber saddle for dumbbell racks incl.
screws per pair.

Monoblock Hanteln und Ablage | monobloc dumbbells and rack

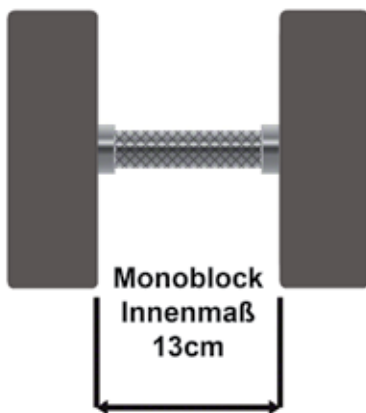

Art.-Nr. 020M-600M
Monoblock Hanteln, gummiert von 2-60 kg
Monobloc dumbbells, in 2-60 kg

Auch mit eigenem Logo
gegen Aufpreis lieferbar!
Own logo available
with extra charge!



Art.-Nr. 7100-RG
Hantelablage 3 x 2,40 m und 3 Standfüße (ohne Hanteln), schwarz/silbergrau, inkl. 30 Paar Sattel
dumbbell rack 3 x 2,40 m and 3 bases (without dumbbells), black/silvergry incl. 30 pairs of rubber saddles.

Monoblock Langhanteln und Ablage | monobloc barbells and rack



Monoblock Gummilanghanteln

monobloc rubber barbells

Maß: 120 cm/ size: 120 cm

Art.-Nr.

RG-100LG	10,00 kg
RG-150LG	15,00 kg
RG-200LG	20,00 kg
RG-250LG	25,00 kg
RG-300LG	30,00 kg
RG-350LG	35,00 kg
RG-400LG	40,00 kg
RG-450LG	45,00 kg
RG-500LG	50,00 kg
RG-550LG	55,00 kg



Auch mit eigenem Logo
gegen Aufpreis lieferbar!

Own logo available
with extra charge!



Art.-Nr. 7004-RG

Langhantelständer (ohne Langhanteln)

Maße: 84 cm x 96 cm x 150 cm

(silbergrau)

barbell rack

size: 84 cm x 96 cm x 150 cm

(silvergrey)

**Polyurethan (PU) Kurz- und Langhanteln, Ø50mm Hantelscheiben |
PU dumbbells, barbells and discs**

Polyurethan (PU) ist einer der hochwertigsten Kunststoffe. Er zeichnet sich u.a. durch eine hohe Zug- und Abriebfestigkeit aus. Er ist verschleiß- und wechselbiegefest und beweist eine sehr gute Schlagzähigkeit. Unsere PU-Hanteln sind verschweißt.

Polyurethane (PU) is one of the highest quality plastics. It stands out among others. By a high tensile and abrasion resistance. It is wear and tear resistant and has a very good impact resistance. Our PU dumbbells are welded.



Art. Nr. PUK020 – PUK500
PU-Kurzhandeln von 2kg – 50kg
wahlweise in 2- oder 2,5kg-Steigung
PU-dumbbells from 2kg – 50kg
alternatively in 2- or 2,5kg-increments

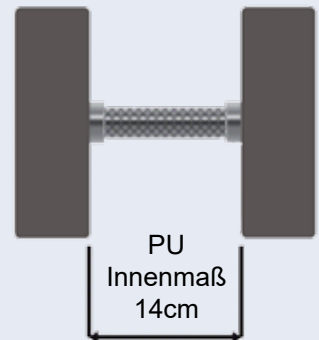

NEU

Eigenes Logo
ohne Aufpreis!
Free own
logo possible!



Art.-Nr. PUS0125 – PUS2500
mit Edelstahlbuchse
PU-Hantelscheiben Ø50mm von 1,25kg – 25kg
PU-Plates from 1,25kg– 25kg
with stainless steel bushing



Art.-Nr. PUL100 – PUL600
PU-Langhanteln von 10kg – 60kg
PU-barbells from 10kg – 60kg

Ablagen für Langhanteln | racks for barbells



Art.-Nr. K7004
Langhantelständer
(ohne Langhanteln)
Maße: 85 cm x 95 cm x 140 cm,
RAL 9006
barbell rack
(without barbells)
for 10 barbells,
size: 85 cm x 95 cm x 140 cm



Art.-Nr. K7004-1
Langhantelständer zur Wand-
befestigung (ohne Langhanteln)
Maße: 85 cm x 49 cm x 140 cm
RAL 9006
barbell rack for wall fixing (without
barbells) size: 85 cm x 49 cm x 140 cm



Art.-Nr. 7004-RG
Langhantelständer
Maße: 84 cm x 96 cm x 150 cm
(silbergrau)
barbell rack, grey
size: 84 cm x 96 cm x 150 cm
(silvergry)



Art.-Nr.

Kettlebells

21-4	4,00 kg gelb / yellow
21-6	6,00 kg grau / grey
21-8	8,00 kg grün / green
21-10	10,00 kg hellblau / light blue
21-12	12,00 kg lila / purple
21-16	16,00 kg rot / red
21-20	20,00 kg orange / orange
21-24	24,00 kg blau / blue
21-28	28,00 kg braun / brown
21-32	32,00 kg schwarz / black

Art.-Nr. K21-R



Art.-Nr. 21-R

Ablage für 8 Kettlebells

Maße: 115 cm x 47 cm x 94 cm

rack for 8 Kettlebells

size: 115 cm x 47 cm x 94 cm

Art.-Nr. K21-R

Komplettsatz bestehend aus Ablage

und Kettlebells von 4 kg bis 32 kg/

4 kg Steigung

8 Kettlebells including rack

Kettlebells from 4 kg to 32 kg/

4 kg increments

Chromhanteln und Ständer | chrome dumbbells and rack



Art.-Nr. K22910-A
Chromhanteln 1 kg-10 kg, je ein Paar
chrome dumbbells 1 kg-10 kg one pair each

Chromhanteln	
Art.-Nr. 22500L	1 kg
Art.-Nr. 22501L	2 kg
Art.-Nr. 22502L	3 kg
Art.-Nr. 22503L	4 kg
Art.-Nr. 22504L	5 kg
Art.-Nr. 22505L	6 kg
Art.-Nr. 22506L	7 kg
Art.-Nr. 22507L	8 kg
Art.-Nr. 22508L	9 kg
Art.-Nr. 22509L	10 kg



Chromhanteln
Die universalen, formschönen
Chromhanteln sind für die verschiedensten
Zwecke geeignet und bilden zusammen
mit dem Hantelständer einen Blickpunkt in
ihrem Trainingsraum!

chrome dumbbells
These all-purpose, stylish chrome dumb-
bells have many uses. Together with the
dumbbell rack they form an eye-catching
combination!

Art.-Nr. K22911-A
Chrom-Hantelständer mit
10 Paar Chromhanteln
1 kg-10 kg
chrome rack with chrome
dumbbells 1 kg-10 kg one pair each

Art.-Nr. 22512
Chromständer, ohne Hanteln
Maße: 41 cm x 46 cm x 122 cm
chrome rack, without dumbbells
size: 41 cm x 46 cm x 122 cm



Art.-Nr. 22913-RG

Hantelständer weiß lackiert (ohne Hanteln), abschließbar.

Maße: 65 cm x 50 cm x 84 cm.

dumbbell rack with white lacquer finish (without dumbbells), lockable. Size: 65 cm x 50 cm x 84 cm.

PVC-Hanteln

Art.-Nr. 24499 0,5 kg blau/ blue

Art.-Nr. 24600 1 kg rot, gelb und grün/ red, yellow and green

Art.-Nr. 24601 1,5 kg rot, grün und blau/ red, green and blue

Art.-Nr. 24602 2 kg rot und blau/ red and blue

Art.-Nr. 24502 3 kg rot und gelb/ red and yellow

Art.-Nr. 24604-B 4 kg blau/ blue

Art.-Nr. 24504 5 kg blau/ blue



Art.-Nr. 22913

Doppelständer, ohne Hanteln

Maße: 63 cm x 45 cm x 122 cm

double rack, without dumbbells

size: 63 cm x 45 cm x 122 cm

Art.-Nr. K22915

Doppelständer mit 40 Stück

1 kg Hanteln

double chrome rack with 40 pc.

1 kg aerobic dumbbells



Art.-Nr. 4056
Latzugstange: 120 cm, voll, 5,2kg
solid lat bar, 120 cm, 5,2kg
Art.-Nr. 4057
Latzugstange: 120 cm, hohl, 2,4kg
tubular lat bar, 120 cm, 2,4kg



Art.-Nr. 4056-G/ Art.-Nr. 4057-G
mit Gummigriff
with rubber covers

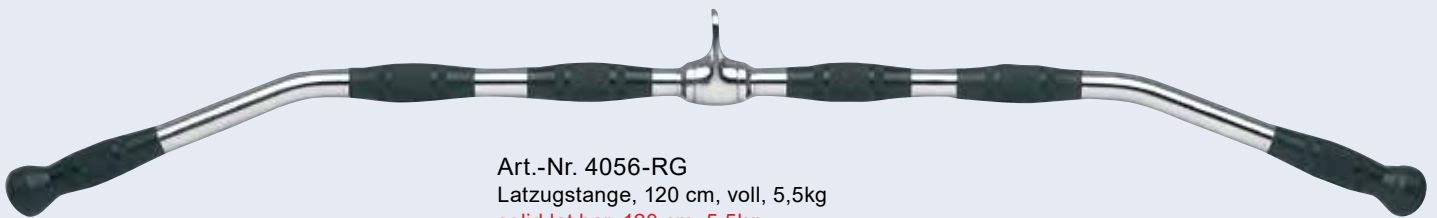

Art.-Nr. 4056-RG
Latzugstange, 120 cm, voll, 5,5kg
solid lat bar, 120 cm, 5,5kg



Art.-Nr. 4057-RG
Latzugstange, 120 cm, hohl, 3kg
tubular lat bar, 120 cm, 3kg

Trizepsgriffe | triceps grips



Art.-Nr. 4040
Trizepsgriff, W-geschwungen, 3,1kg
triceps grip, w-type, 3,1kg



Gummihandgriffe, ø 30 mm
Art.-Nr. 62220 15 cm
62221 20 cm
62222 25 cm
rubber covers ø 26 mm
Art.-Nr. 62223 15 cm
62224 20 cm
62227 40 cm



Art.-Nr. 4053
Trizepsgriff, Pilzform
triceps pressdown



Art.-Nr. 4058
Trizepsgriff, Wellenform, 3,3kg
triceps curled grip, 3,3kg



Art.-Nr. 4058-G
mit Gummigriff
with rubber covers



Art.-Nr. 4059
Trizepsgriff, voll, 2,4 kg, 45 cm
solid triceps grip, 2,4kg, 45 cm



Art.-Nr. 4059-G
mit Gummigriff
with rubber covers



Art.-Nr. 4059-RG
Trizepsgriff, 2,5 kg, 50 cm
with rubber covers

Art.-Nr. 4060
Trizepsgriff, hohl, 1,1 kg, 45 cm
solid triceps grip, tubular, 1,1kg, 45 cm

Art.-Nr. 4060-G
mit Gummigriff
with rubber covers



Art.-Nr. 4061
Trizepsgriff, gebogen, 3,1kg
triceps grip, 3,1kg



Art.-Nr. 4061-G
mit Gummigriff
with rubber cover



Art.-Nr. 4061-RG
Trizepsgriff, gebogen, 3,1kg
triceps grip, 3,1kg



Art.-Nr. 4066
Trizepsgriff, W-Form, 2,7kg
triceps bar, w-type, 2,7 kg

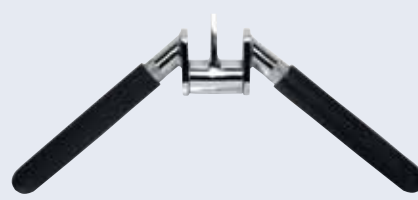

Art.-Nr. 4066-G
mit Gummigriff
with rubber cover

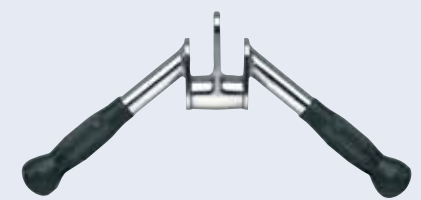

Art.-Nr. 4066-RG
Trizepsgriff, W-Form, 2,8kg
triceps bar, w-type, 2,8kg



Art.-Nr. 4069
Halbrunder Trizepsgriff, 2,1kg
lat bar, half rounded, 2,1kg



Art.-Nr. 4069-G
mit Gummigriff
with rubber cover



Art.-Nr. 4081
Grosser Pilzgriff, 2,5kg
triceps pressdown, 2,5kg



Art.-Nr. 4070
kleiner Trizepsgriff, hohl, 0,7kg, 36 cm
small triceps grip, tubular, 0,7kg, 36 cm



Art.-Nr. 4070-G
mit Gummigriff
with rubber cover



Art.-Nr. 4421 Strick
Fitness-Handschuhe, Strick
training gloves, knit wear
Gr. S-XL/ size S-XL

Bügelzuggriffe | single hand grips



Art.-Nr. 4048
Zuggriff; Nylon, max. Belastung bis 5kg
single hand grip, nylon, max. load up to 5kg



Art.-Nr. 4049
Bügelzuggriff, kurz, 0,55kg
single hand grip, short, 0,55kg



Art.-Nr. 4051
Bügelzuggriff, lang, 0,9kg
single hand grip, long, 0,9kg



Art.-Nr. 4078
Bügelzuggriff, flach, 1,2kg
single hand grip, flat, 1,2kg



Art.-Nr. 4079
Bügelzuggriff, offen, 1,3kg
single hand grip, open, 1,3kg



Art.-Nr. 310-A
Fitness-Handschuhe
training gloves
Gr. S-XL/ size S-XL

Hufgriffe | horse shoe grips



Art.-Nr. 4043-RG
Nackenzuggriff, Hufgriff, 6kg
neck pull, 6kg

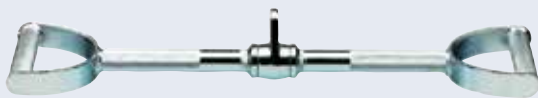

Art.-Nr. 4054
Latzug, gerade, Hufgriff: 60 cm, 4,1kg
lat bar, 60 cm, 4,1kg

Art.-Nr. 4054-1
Latzug, gerade, Hufgriff: 75 cm, 4,6 kg
lat bar, 75 cm, 4,6kg

Art.-Nr. 4055
Latzug, gerade, Hufgriff: 82 cm, 4,9kg
lat bar, 82 cm, 4,9kg



Art.-Nr. 4064
Latzugstange, abgewinkelt, 4,8kg
Hufgriff: 75 cm
bent lat bar, 75 cm, 4,8kg

Art.-Nr. 4063
Latzugstange, abgewinkelt, 5,5kg
Hufgriff: 100 cm
bent lat bar, 100 cm, 5,5kg



Art.-Nr. 4065
Trizepszug V-Form, Hufgriff, 3,3kg
triceps grip, V-type, 3,3kg



Art.-Nr. 4065-RG
Trizepszug, V-Form, Hufgriff, 3,3kg
triceps grip, v-type, 3,3kg

Parallelgriffe | seated lat bars



Art.-Nr. 4044
Parallelgriff, schmal, drehbar, 2kg
revolving seated lat bar



Art.-Nr. 4044-RG
Parallelgriff, schmal, drehbar, 1,9kg
revolving seated lat bar



Art.-Nr. 310
Fitness-Handschuhe
training gloves
Gr. S-XL/ size S-XL



Art.-Nr. 4052
Parallelgriff, schmal, hohl, 1,5kg
seated lat pull bar, tubular, 1,5kg



Art.-Nr. 4062
Parallelgriff, breit, voll, 2kg
seated lat bar, 2kg



Art.-Nr. 4076
Schräger Paragriff, 0,9kg
seated lat pull bar, 0,9kg

Multigriffe | multiple grips



Art.-Nr. 4050
Multigriff, breit, 3,5kg
multiple grip, 3,5kg



Art.-Nr. 4050-G
mit Gummigriff
with rubber cover



Art.-Nr. 4050-RG
Multigriff, Rennlenkerform, 3,7kg
multiple grip, 3,7kg



Art.-Nr. 4077
Trizepsseil, natur, 80 cm
triceps rope, natural



Art.-Nr. 4077-A
Trizepsseil, schwarz, 70 cm
triceps rope black, 70 cm



Art.-Nr. 4077-1
Trizepsseil, natur, 150 cm
triceps rope, natural, 150 cm



Art.-Nr. 4077-B
Trizepsseil, einfach, 36 cm
single triceps rope, 36 cm

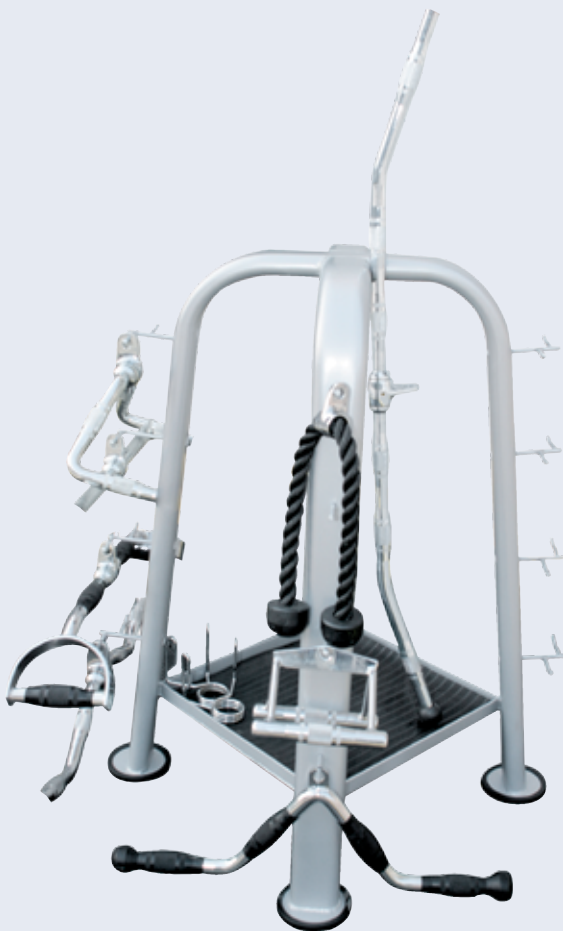

Art.-Nr. 054
Ständer für Zugstangen, grau
Maße: 79 cm x 79 cm x 102 cm
(ohne Zubehör)
rack for lat bars, grey
size: 79 cm x 79 cm x 102 cm
(without accessories).





Seit 1986 arbeiten wir mit einem deutschen Sportgerätehersteller erfolgreich zusammen, und können Ihnen so „**100% Made in Germany**“ anbieten. Über 200 verschiedene Sportgeräte (von Adduktorenmaschine bis Zuggurt) für das Trainieren sämtlicher Körper- und Muskelpartien sind lieferbar. Durch langjährige Erfahrungen zeichnen sich alle Trainingsgeräte durch folgende Eigenschaften aus und gehören zu den Besten auf dem Markt:

- durchdachte Biomechanik
- einfache Bedienbarkeit
- komfortables Training
- hervorragende Zuverlässigkeit
- attraktives Design
- lange Lebensdauer
- erstklassige Verarbeitung

Darüber hinaus sind maßgeschneiderte, kundenorientierte und individuelle Lösungen für Ihr Studio möglich.

Wir freuen uns über Ihre Anfragen.

Art.-Nr. 272E

Multirack schwarz

ca. 240 cm x 220 cm x 225 cm,

Vorrichtung für Hantelstange mit linearer Führung, Bügel zum Einhängen von Seilen und Tubes, Klimmzugstange, Buchse zur Fixierung von Langhantel für Rumpfübungen, Dip-Bügel, Tritt für Sprungübungen.

multirack black

approx. 240 cm x 220 cm x 225 cm,

device for bar with linear guide, handles for ropes and tubes, pull-up bar, socket for fixing a bar for body exercises, dip bar, passage for jumping exercises.

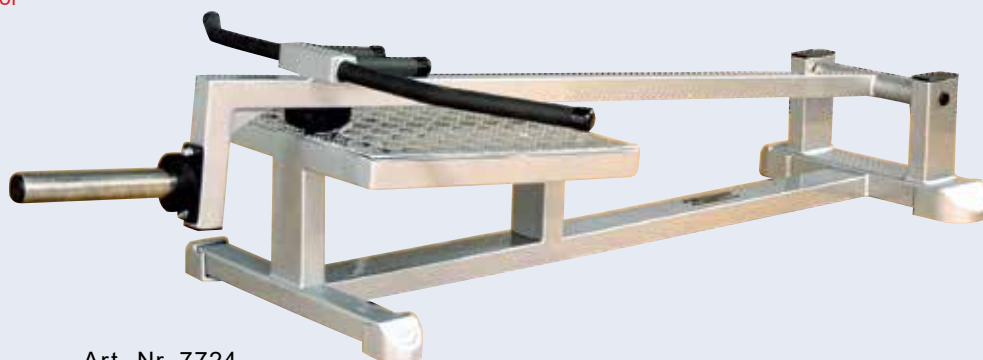

Art.-Nr. 7724

Bodenhantel

Maße: 200 cm x 120 cm x 50 cm

T-bar, size: 200 cm x 120 cm x 50 cm



Art.-Nr. 77017
Kniebeugenständer
Maße: 150 cm x 170 cm x 170 cm
squat rack
size: 150 cm x 170 cm x 170 cm

Since 1986 we have been cooperating closely with a German producer developing and manufacturing „**100% Made in Germany**“. They produce over 200 different machines and benches for the training of all body and muscle parts. Through their many years of experience, all of the training devices are characterized by the following features and are among the best on the market:

- thought-through biomechanics
- easy to use
- comfortable training
- excellent reliability
- attractive design
- long lifetime
- first-class processing

They offer tailor-made, customer-oriented and individual solutions for you studio and physiotherapy.

We are looking forward to your inquiries.



Art.-Nr. 7072
Power-Rack
Maße: 140 cm x 170 cm x 220 cm
power-rack
size: 140 cm x 170 cm x 220 cm



Art.-Nr. 7084
Scott-Curl, sitzend
Maße: 90 cm x 80 cm x 100 cm
scott-Curl seated
size: 90 cm x 80 cm x 100 cm

Cross fit | Cross fit



Art.-Nr. 2196
Zugschlitten (ohne Scheiben) für optimales
Widerstands-und Krafttraining.
power sledge for resistance workout



Art.-Nr. 4077-2
Schwungseil, natur 10 m lang,
4 cm Durchmesser
rope, natural material, 10m length, Ø4cm



Art.-Nr. 2195
Nylonseil, schwarz 9,14 m lang,
3,6 cm Durchmesser
rope, nylon black, 9,14m length, Ø3,6cm



Art.-Nr. 2197
Torsonator
Das ultimative Trainingsgerät für den
Oberkörper (Stange nicht enthalten).
The perfect training for the upper body
(bar not included).



Art.-Nr. 2190
Boxsack zum Hängen
ca. 140 x 35 cm, ca. 36 kg
hanging Box Bag 140 cm x 35 cm, 36 kg



Art.-Nr. 78
Trainingssschlingen, verstellbar
slings, adjustable

Gymnastik- und Medizinbälle inkl. Ablagen | gymnastic and medicine balls incl. racks

Art.-Nr. 71
Art.-Nr. 72
Art.-Nr. 73

Gymnastikbälle / gym balls
blau ø 65 cm / blue ø 65 cm
silber ø 75 cm / silver ø 75 cm
rot ø 55 cm / red ø 55 cm



NEU

Art.-Nr. 73-L
Luftpumpe
pump



Art.-Nr. 200011
Ablage für 5 Medizinbälle
rack for 5 medicine balls

Medizinbälle medicine balls

- Art.-Nr.
200012 1,00 kg gelb / yellow
200013 2,00 kg orange / orange
200014 3,00 kg grün / green
200015 4,00 kg blau / blue
200016 5,00 kg rot / red



Art.-Nr. 7123
Ablage ohne Bälle für ca.
12 Gymnastikbälle, 180 cm hoch.
rack without balls for approx. 12 Gym balls,
180 cm high.



Art.-Nr. RG1248

Bauchabroller

Optimales Trainingsgerät für einen flachen Bauch. Rundumlaufender Qualitäts-schaumstoff für perfekten „Grip“ in allen Haltepositionen. Powerbelt für Intensiv-Bauch-Training.

Perfect for abdominal excersises and workouts rubber cover and powerbelt includes.



Ball-ance Art.-Nr. 79

Ball-ance Halbball inkl. Luftpumpe und 2 Latex-Gummigriffe

half ball incl. pump and 2 tubes.



Art.-Nr. 4039
2 Ringe mit Gurt

2 excercising rings with straps

Art.-Nr. 71-4
Art.-Nr. 71-3
Art.-Nr. 71-2
Art.-Nr. 71-1

Igelbälle
hedge-hog ball
7 cm grün/ green
8 cm gelb/ yellow
9 cm rot/ red
10 cm blau/ blue



Toner, Tubes und Body-Bänder | toner, tubes and body-bands

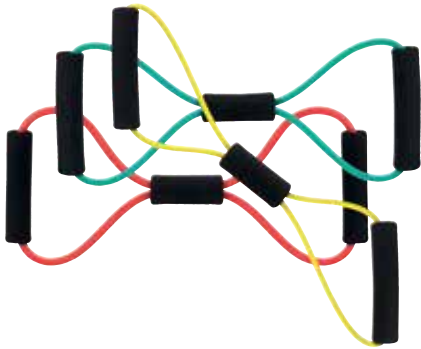

Art.-Nr. 100
Body-Toner, gelb: leicht
yellow: light
Art.-Nr. 100-1
Body-Toner, grün: mittel
green: medium
Art.-Nr. 100-2
Body-Toner, rot: stark
red: strong



Art.-Nr. 90
Rubber Band, gelb: leicht
yellow: light
Art.-Nr. 90-1
Rubber Band, rot: mittel
green: medium
Art.-Nr. 90-2
Rubber Band, grün: stark
red: strong



Art.-Nr. 110
Body-Ring, gelb: leicht
yellow: light
Art.-Nr. 110-1
Body-Ring, grün: mittel
green: medium
Art.-Nr. 110-2
Body-Ring, rot: stark
red: strong



Art.-Nr. 70
Tube, gelb: leicht
yellow: light
Art.-Nr. 70-1
Tube, grün: mittel
green: medium
Art.-Nr. 70-2
Tube, rot: stark
red: strong
Art.-Nr. 70-3
Tube blau: extra stark
blue: extra strong



Art.-Nr. 80
Step-Tube, gelb: leicht
yellow: light
Art.-Nr. 80-1
Step-Tube, grün: mittel
green: medium
Art.-Nr. 80-2
Step-Tube, rot: stark
red: strong





Art.-Nr. 101
Jump-Stretch, violett: leicht
violet: light
Art.-Nr. 102
Jump-Stretch, grün: mittel
green: medium
Art.-Nr. 103
Jump-Stretch, blau: stark
blue: strong

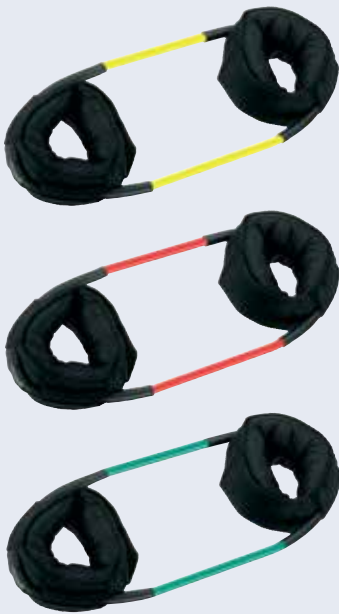

Art.-Nr. 120
Cuff-Tube, gelb: leicht
yellow: light
Art.-Nr. 120-1
Cuff-Tube, rot: mittel
red: medium
Art.-Nr. 120-2
Cuff-Tube, grün: stark
green: strong



Art.-Nr. 60-1
Fitness-Band, gelb: leicht, 25 m
yellow: light, 25 m
Art.-Nr. 60-2
Fitness-Band, rot: mittel, 25 m
red: medium, 25 m
Art.-Nr. 60-3
Fitness-Band, grün: stark, 25 m
green: strong, 25 m
Art.-Nr. 60
Fitness-Band, blau: extra stark, 25 m
blue: extra strong, 25 m

Art.-Nr. 60-4
Clip für Fitnessband
clip for fitness band
Art.-Nr. 60-15
gelb: leicht, 5,5 m
yellow: light, 5,5 m
Art.-Nr. 60-25
rot: mittel, 5,5 m
red: medium, 5,5 m
Art.-Nr. 60-35
grün: stark, 5,5 m
green: strong, 5,5 m
Art.-Nr. 60-45
schwarz: extra stark, 5,5 m
black: extra strong, 5,5 m

Gymnastikmatten und Mattenhalter | gymnastic mats and mat racks

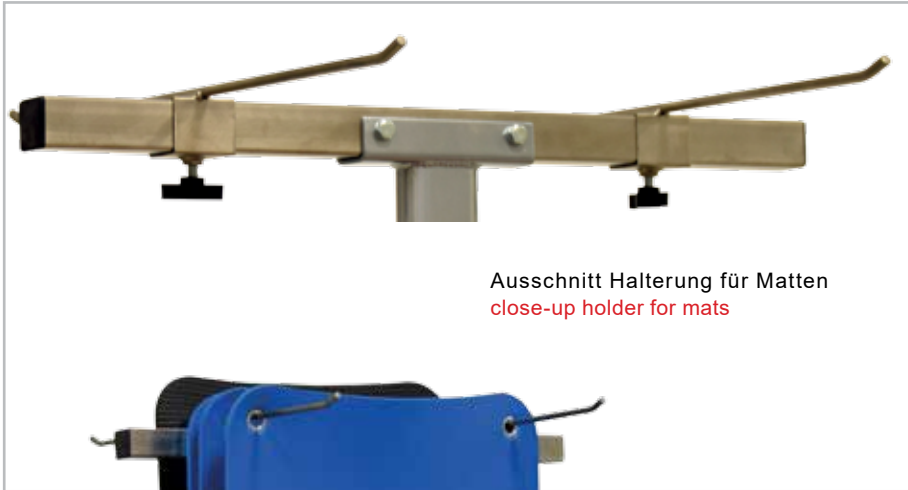

Ausschnitt Halterung für Matten
close-up holder for mats

Art.-Nr. 48615

Mattenhalter

Maße: 60 cm x 5 cm (Metall, grau)
(Für ca. 10 Matten, zur Befestigung
an der Wand)

holder for mats, size: 60 cm x 5 cm
(metal, grey) for approx. 10 mats,
wall fastening)

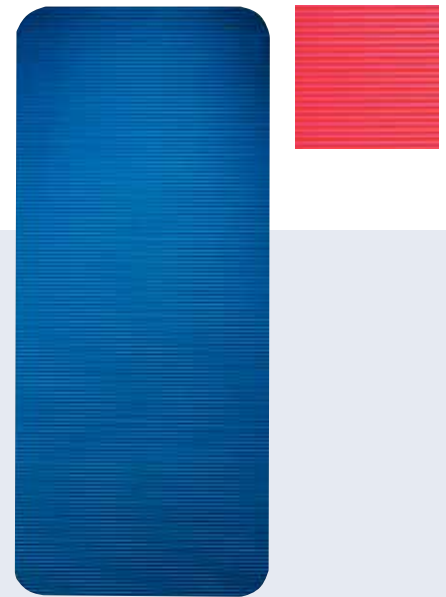

Gymnastikmatten

**Verschiedene Größen und Farben
auf Anfrage.**

Alle Matten mit und ohne Ösen erhältlich.
SANITIZED® - veredelt (antibakteriell und
pilzverhindernd),

zertifiziert nach Öko-Tex-100.

Unsere Standardgröße: 140/60/1cm

Unsere Standardfarben: skyblue und rot
gymnastic mats

Available in different sizes and colors.

All mats with and without loops.

The mats are hygienic by SANITIZED®,
certificate Öko-Tex-100.

Neither bacteria nor fungi can exist here.

Our standard size: 140/60/1cm

Our standard color: skyblue and red

Art. 8200-x

Yoga Matte

in unterschiedlichen Farben erhältlich

Maße: 180/60/0,5cm

yoga mat

available in different colors

size: 180/60/0, 5cm



Art.-Nr. 8106-RG

Fahrbarer Mattenwagen ohne Matten

mobile rack without mats

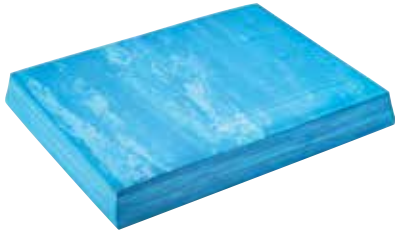

Art.-Nr. 9000
Soft Board – viereckig
47 cm x 38 cm x 6 cm mit Anti-Rutsch-Struktur



Art.-Nr. 9002
Soft Board – sechseckig
35 cm x 40 cm x 6 cm mit Anti-Rutsch-Struktur



Art.-Nr. 417
Gymnastikseil/ jump rope

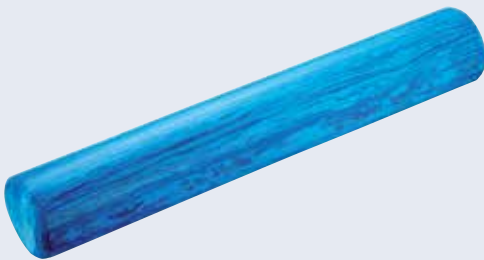

Art.-Nr. 9001
Pilates Rolle largo
91 cm x 15 cm

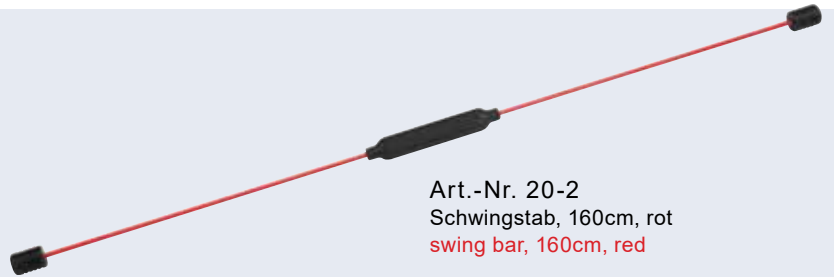

Art.-Nr. 20-2
Schwingstab, 160cm, rot
swing bar, 160cm, red

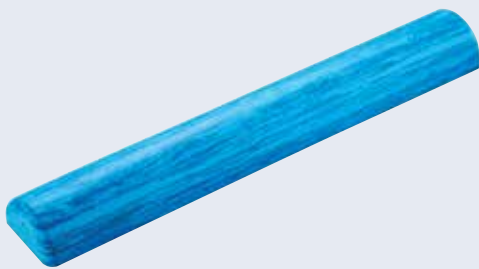

Art.-Nr. 9003
Pilates Rolle media
91 cm x 15 cm

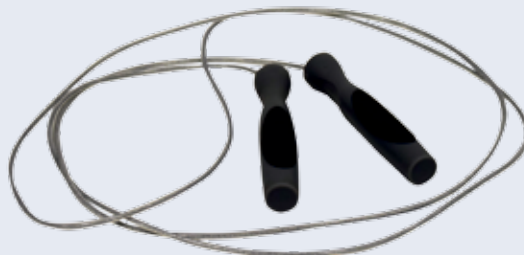

Art.-Nr. 18010
Springseil
jump-rope

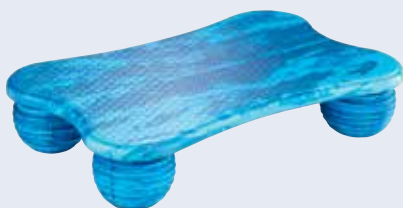

Art.-Nr. 9007
Soft Board – 4 Eckfüße
60 cm x 39 cm x 12,5 cm
mit Anti-Rutsch-Struktur

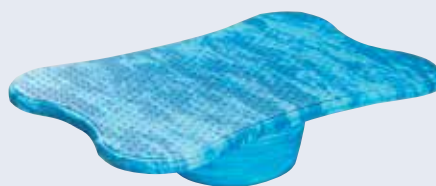

Art.-Nr. 9008
Soft Board – hoher Mittelfuß
60 cm x 39 cm x 12 cm
mit Anti-Rutsch-Struktur

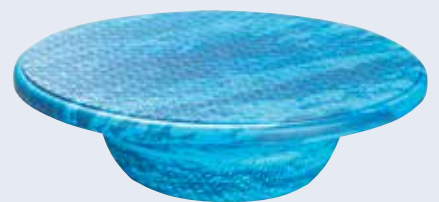

Art.-Nr. 9009
Softboard – rund ø 39 cm x 9 cm
mit Anti-Rutsch-Struktur

Workout Bars, Ablagen und Steps | workout bars, rack and steps



Art.-Nr. 50-2 2 kg blau/ blue 140 cm



Art.-Nr. 50-3 3 kg rot/ red 140 cm



Art.-Nr. 50-4 4 kg grün/ green 140 cm



Art.-Nr. 50-5 5 kg gelb/ yellow 140 cm



Art.-Nr. 50-7 7 kg grau/ grey 140 cm

Workout Bar

Praktisches und benutzerfreundliches Trainingsgerät (innen mit griffsympatischem Gummiüberzug) für produktives Muskeltraining.

Practical and easy to use! Workout Bar with foam grip for effective free-weight training.



Art.-Nr. 053

Workout Bar Rack

Der praktische Ständer (ohne Stangen) für unsere Workout Bars. Kann in 4 Fächern ca. 20 Stangen aufnehmen.

Maße: 100 cm x 60 cm x 120 cm

A practical rack (without bars) for approx. 20 Workout Bars. Size: 100 cm x 60 cm x 120 cm.



Art.-Nr. 68

Aerobic-Step

Optimales Trainingsgerät für den professionellen Einsatz. Schnell auf- und abgebaut, leicht (6,5 kg) und platzsparend zu lagern. Höhenverstellbar in 3 Stufen.

Maße: L 90 cm x B 32,5 cm x H 25 cm die Höhe der einzelnen Elemente beträgt 5 cm.

High quality step for professional use.

Easy to assemble and space-saving to store.

Weight: 6,5 kg, 3 levels of training heights.

size: 90 cm x 32,5 cm x 25 cm (l/w/h)

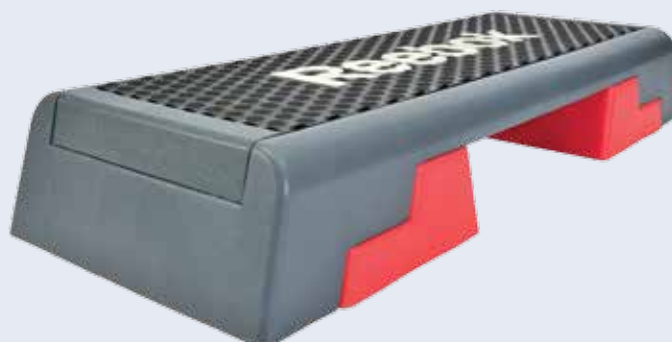

Art.-Nr. Nr. 69

Reebok-Step

Mono-Block Konstruktion, rutschfeste Bodenelemente und Auftrittsfläche, dreifach höhenverstellbar (15,2 cm, 20,3 cm 25,4 cm).

Maße: L 90 cm x B 35 cm, Gewicht: 7,5 kg

one piece construction, non-slip floor blocks and steppanel, adjusts to 3 levels of training heights (15,2 cm, 20,3 cm 25,4 cm). size: (l/w) 90 cm x 35 cm, weight: 7,5 kg



Art.-Nr. 49000 140 cm x 60 cm
Art.-Nr. 49001 180 cm x 60 cm
Art.-Nr. 49002 180 cm x 100 cm

Floor-Protect Geräteunterlagen, transparent. Der hochwertige Vinylbelag legt sich plan auf den zu schützenden Boden und vermeidet so Stolperkanten durch hochstehende Ecken. Er ist durch die porenfreie Oberfläche leicht zu reinigen.

Floor-Protect mats
High quality, transparent flooring provides a maximum protection for sensitive surfaces. Creates a safe and stable platform and is easy to clean.



Art.-Nr. 4400
Handschutzpolster aus Vinyl SANITIZED® - veredelt (antibakteriell und pilzverhindernd), zertifiziert nach Öko-Tex-100. Andere Farben im Wechsel möglich.
hand pads vinyl
The pads are hygienic by SANITIZED®, certificate Öko-Tex-100. Neither bacteria nor fungi can exist here. Colors not selectable.



Art.-Nr. 7095
Universalbank
Gestell silbergrau, Polster Schwarz
Maße: 120/40/45cm
In allen RAL-Tönen mit Aufpreis erhältlich
universal bench
Frame silvergrey, upholstery black
size: 120/40/45cm
available in all RAL-colors with extra charge

Handschuhe, Gewichtsmanschetten, Gravity Boots | gloves, wrist and ankle weights, gravity boots



Art.-Nr. 4421 Strick
Fitness-Handschuhe, Strick
training gloves, knit wear
Gr. S-XL/ size S-XL



Art.-Nr. 310
Fitness-Handschuhe
training gloves
Gr. S-XL/ size S-XL



Art.-Nr. 310-A
Fitness-Handschuhe
training gloves
Gr. S-XL/ size S-XL



Art.-Nr. 48600-1
2 x 1,25 kg,
Fuss-Gewichtsmanschetten in Schmetterlingsform. Ideal für sämtliche Laufsportarten und beim Step-workout.
ankle weights, the perfect product for running and exercise.



Art.-Nr. 48601
2 x 0,5 kg
Gewichtsmanschetten Ringform
Ideal für alle Boxsportarten, Walken und Joggen!
wrist weights, ring-type, ideal for boxing exercises, walking and jogging!



Art.-Nr. 48602
2 x 0,5 kg,
Gewichtsmanschetten mit Klettverschluss und Daumenöffnung – für bessere Griffbarkeit.
Ideal für alle Box- und Laufsportarten.
wrist weights with a special thumbhole for a better fit.



Art.-Nr. 48603
Gewichtsmanschette mit Gelfüllung, 2 x 1 kg
wrist weights with jelly filling, 2 x 1 kg



Art.-Nr. 48604
Gr. M/ size M
Gravity Boots/ gravity boots



Art.-Nr. 48604-A
Gr. L/ size L
Gravity Boots/ gravity boots

Trainingszubehör | training accessories



Art.-Nr. 484
Fussschlaufe mit Klettverschluss
foot loop with velcro fastening

Art.-Nr. 480
Fusschlaufe: Ringform
foot loop: ring-type

Art.-Nr. 427
Fusschlaufe, Material:
Leder, verstellbar
foot loop, material: leather



Art.-Nr. 416
Latzughilfe, Material: Leder (Paar)
wrist straps, material: leather (pair)

Art.-Nr. 416-A
Latzughilfe mit Klettverschluss (Paar)
wrist straps with velcro fastening
Material: Leder
material: leather (pair)

Art.-Nr. 418
Bavaria-Latzughilfe (Paar)
bavarian wrist straps (pair)



Art.-Nr. 485
Oberarmschlaufen (Paar) mit Ring 40 cm
upper arm training loops with a ring 40 cm
(pair)



Art.-Nr. K481
Bauchtrainingschlaufen (Paar), Länge mit
Karabiner 65 cm, ohne 43 cm
abdominal training loops, size with snap
hook 65 cm, without 43 cm (pair)



Art.-Nr. 483
Lederkopfband
leather head belt



Art.-Nr. RG0540
Gusshantel-Set im Koffer 2 Kurzhantel-
stangen mit Sternverschluss,
4 x 1,25 kg und 4 x 2,5 kg Gussscheiben
portable cast iron dumbbell set
2 dumbbell bars with star fastener,
4 x 1,25 kg and 4 x 2,5 kg cast iron discs



Art.-Nr. 2191
Bizeps-Blaster ohne Stange | without bar
Für konzentriertes Bizepstraining.



Art.-Nr. 22-A
Geräterolle, 25 cm
foam roll, 25 cm



Art.-Nr. RG1237
Liegestütz-Set
push up set



Art.-Nr. RG 1237-1
Liegestütz-Set, drehbar
push-up set, rotating



**ACHTUNG:
NEUE ARTIKELNUMMERN!**

- Karabinerhaken
KB05 5cm lang, für Dipgürtel
KB08 8cm lang
KB14 14cm lang
KB18 18cm lang, für Bauchtrainingsschlaufen
Hooks
KB05 5cm length, for dip belt
KB08 8cm length
KB14 14cm length
KB18 18cm length, abdominal training loops



Art.-Nr. 482-1
Dipgürtel, Material: Nylon
dip belt, material: nylon

Art.-Nr. 482
Dipgürtel, Material: Kunstleder
dip belt, material: leatherette

MFsport GmbH
Industriestraße 11
D-33803 Steinhagen

fon +49(0)5204|99557-0
fax +49(0)5204|99557-20
www.mf-sport.com

Direkte Durchwahlen

Kathrin Bernard +49(0)5204 99557-11
KathrinB@mf-sport.com

Christine Ulrich +49(0)5204 99557-12
ChristineU@mf-sport.com

Monika Flicker +49(0)5204 99557-10
MonikaF@mf-sport.com